

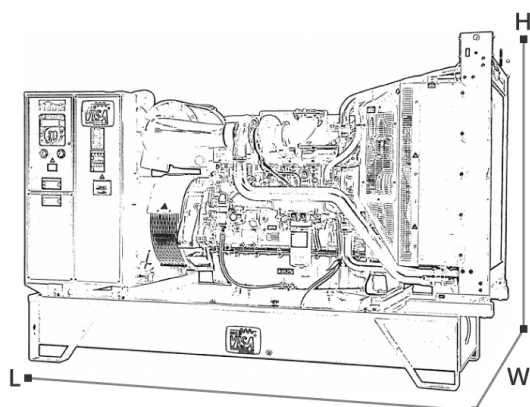

POWERFULL "B"



For illustrative purposes only

ENGINE

Engine brand	DEUTZ
Engine model	BF4M1013FC
Cylinders	4
Speed	1500 r.p.m.
Cubic capacity	4.76 l
Air intake	Turbocharged
Standard voltage	12 Vdc
Optional voltage	24 Vdc
Sae	3-11½
BMEP	2080 kPa
Cooling	Water
Flywheel P.R.P. Power	117.6 kW
Flywheel Stand-by Power	124.0 kW
Fuel Cons. at 100% (L.T.P.)	31.2 l/h
Fuel Cons. at 100% (P.R.P.)	29.3 l/h
Fuel Cons. at 75% (P.R.P.)	21.7 l/h
Fuel Cons. at 50% (P.R.P.)	14.9 l/h
Fuel Cons. at 25% (P.R.P.)	8.7 l/h
Electronic regulator	Standard
Precision class	G2
Oil quantity	17.0 l
Engine Antifreeze capacity	19.7 l
Radiator type	Tropical
Heat from radiator	86.4 kW
Heat from exhaust	0.0 kW
Heat from radiation	0.0 kW
Exhaust temperature	530 °C
Cooling air flow	150.00 m³/min
Combustion air flow	0.00 m³/min
Exhaust gas flow	23.15 m³/min
TA Luft	Not available
TA Luft/2	Not available
EPA	Not available
Stage	Stage 2

MAIN DATA

Continuous power (PRP)	130.0 (kVA)
Continuous power (PRP)	104.0 (kW)
Stand-by power (LTP)	137.0 (kVA)
Stand-by power (LTP)	109.6 (kW)
Voltage • Frequency • Power Factor	415V • 50Hz • 0.8 cosφ
Sound pressure 7 m.	0.0 dBA

DIMENSIONS AND WEIGHT

Width	1090 mm
Length	2350 mm
Height	1800 mm
Weight	1360 kg

ALTERNATOR

Alternator brand	MARELLI
Alternator model	MJB225LA4
P.R.P. Power	132.0 kVA
L.T.P. Power	145.0 kVA
Connection	Series star
Phases	3PH+N
Winding	12 terminals 50-60Hz Winding M0
Terminal Number	12 nr.
IP Protection	23
Electronic regulator	M16FA655A
Precision	0.5 ± %

BASEFRAME

Model	T2
Standard tank	520 l
Optional tank	0 l
Oversized tank*	0 l

CANOPY & SILENCER

Canopy model	SENZA COFANO
Silencer model	MS 20
Silencer outlet diameter	89.0 mm

Standard reference conditions temperature 25°C, altitude 100m asl, relative humidity 30%, atmospheric pressure 100 kPa (1 bar), power factor 0.8 lag, balanced load - non distortional. Fuel consumption is nominal and refers to specific weight 0,850kg/l. Sound power values refer to free field conditions: the installation site may influence the values. Dimensions, weights and other specifications contained in the technical data sheet and related attachments are nominal, subject to tolerances and refer to the model with standard equipment; any optional and additional equipment/accessories can modify weight, dimensions, performance.

P.R.P. Prime Power-Continuous power at variable load: The power that a genset can supply in continuous service at a variable load for an unlimited number of hours per year while respecting the maintenance intervals established in the environmental conditions stated by the Manufacturer. according to ISO8528-1. The average power supplied over time and any applicable overload must be less than the percentages stated by the Manufacturer.

L.T.P. Limited-time running power-Limited power: The maximum power that a genset can supply for a limited time respecting the maintenance intervals established in the environmental conditions stated by the Manufacturer according to ISO 8528-1. The number of hours per year is stated by the Manufacturer. Overload is not permitted.

