

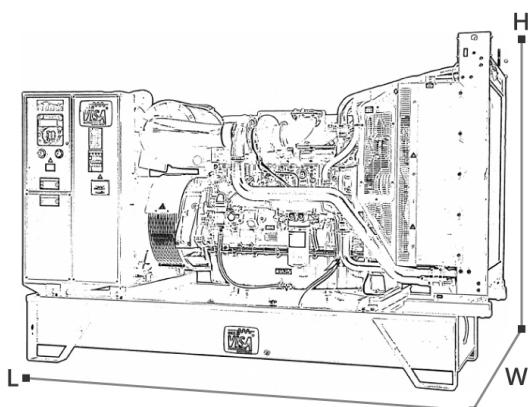

POWERFULL "B"



For illustrative purposes only

ENGINE

Engine brand	VOLVO-PENTA
Engine model	TAD734GE
Cylinders	6
Speed	1500 r.p.m.
Cubic capacity	7.15 l
Air intake	Turbocharged
Standard voltage	24 Vdc
Optional voltage	Vdc
Sae	2-11½
BMEP	2500 kPa
Cooling	Water
Flywheel P.R.P. Power	215.4 kW
Flywheel Stand-by Power	240.4 kW
Fuel Cons. at 100% (L.T.P.)	60.9 l/h
Fuel Cons. at 100% (P.R.P.)	54.5 l/h
Fuel Cons. at 75% (P.R.P.)	44.3 l/h
Fuel Cons. at 50% (P.R.P.)	32.8 l/h
Fuel Cons. at 25% (P.R.P.)	18.8 l/h
Electronic regulator	Standard
Precision class	G3
Oil quantity	29.0 l
Engine Antifreeze capacity	8.0 l
Radiator type	Tropical
Heat from radiator	117.0 kW
Heat from exhaust	160.0 kW
Heat from radiation	24.0 kW
Exhaust temperature	495 °C
Cooling air flow	190.00 m³/min
Combustion air flow	16.10 m³/min
Exhaust gas flow	33.00 m³/min
TA Luft	Not available
TA Luft/2	Not available
EPA	Not available
Stage	Stage 2

MAIN DATA

Continuous power (PRP)	250.0 (kVA)
Continuous power (PRP)	200.0 (kW)
Stand-by power (LTP)	275.0 (kVA)
Stand-by power (LTP)	220.0 (kW)
Voltage • Frequency • Power Factor	415V • 50Hz • 0.8 cosφ
Sound pressure 7 m.	0.0 dBA

DIMENSIONS AND WEIGHT

Width	1120 mm
Length	2650 mm
Height	1900 mm
Weight	2100 kg

ALTERNATOR

Alternator brand	STAMFORD
Alternator model	UCDI274K
P.R.P. Power	250.0 kVA
L.T.P. Power	275.0 kVA
Connection	Series star
Phases	3PH+N
Winding	12 terminals Winding 311
Terminal Number	12 nr.
IP Protection	23
Electronic regulator	SX460
Precision	1.5 ± %

BASEFRAME

Model	T2
Standard tank	520 l
Optional tank	0 l
Oversized tank*	0 l

CANOPY & SILENCER

Canopy model	SENZA COFANO
Silencer model	MS 25
Silencer outlet diameter	114.0 mm

Standard reference conditions temperature 25°C, altitude 100m asl, relative humidity 30%, atmospheric pressure 100 kPa (1 bar), power factor 0.8 lag, balanced load - non distortional. Fuel consumption is nominal and refers to specific weight 0,850kg/l. Sound power values refer to free field conditions: the installation site may influence the values. Dimensions, weights and other specifications contained in the technical data sheet and related attachments are nominal, subject to tolerances and refer to the model with standard equipment; any optional and additional equipment/accessories can modify weight, dimensions, performance.

P.R.P. Prime Power-Continuous power at variable load: The power that a genset can supply in continuous service at a variable load for an unlimited number of hours per year while respecting the maintenance intervals established in the environmental conditions stated by the Manufacturer. according to ISO8528-1. The average power supplied over time and any applicable overload must be less than the percentages stated by the Manufacturer.

L.T.P. Limited-time running power-Limited power: The maximum power that a genset can supply for a limited time respecting the maintenance intervals established in the environmental conditions stated by the Manufacturer according to ISO 8528-1. The number of hours per year is stated by the Manufacturer. Overload is not permitted.

The data contained in this document is nominal and refers to the standard equipped model and is not binding. Visa S.p.A. reserves the right to revise the information without notice per our policy of continuous product development and improvement.

