

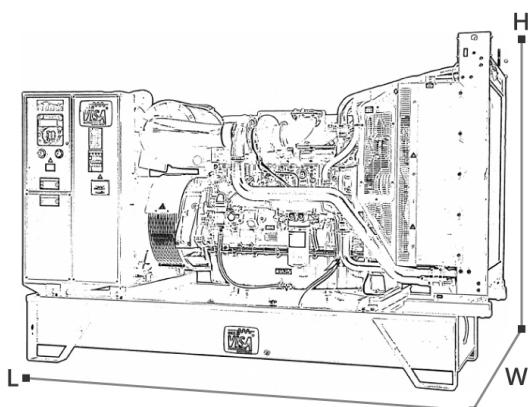

POWERFULL "B"



For illustrative purposes only

ENGINE

Engine brand	FPT IVECO
Engine model	N67TM4
Cylinders	6
Speed	1500 r.p.m.
Cubic capacity	6.70 l
Air intake	Turbocharged
Standard voltage	12 Vdc
Optional voltage	24 Vdc
Sae	3-11½
BMEP	1850 kPa
Cooling	Water
Flywheel P.R.P. Power	149.7 kW
Flywheel Stand-by Power	165.0 kW
Fuel Cons. at 100% (L.T.P.)	42.2 l/h
Fuel Cons. at 100% (P.R.P.)	36.6 l/h
Fuel Cons. at 75% (P.R.P.)	27.5 l/h
Fuel Cons. at 50% (P.R.P.)	18.0 l/h
Fuel Cons. at 25% (P.R.P.)	0.0 l/h
Electronic regulator	On request
Precision class	
Oil quantity	17.2 l
Engine Antifreeze capacity	10.5 l
Radiator type	Tropical
Heat from radiator	87.5 kW
Heat from exhaust	118.0 kW
Heat from radiation	21.0 kW
Exhaust temperature	497 °C
Cooling air flow	228.00 m³/min
Combustion air flow	0.00 m³/min
Exhaust gas flow	26.50 m³/min
TA Luft	Not available
TA Luft/2	Not available
EPA	Not available
Stage	Not available

MAIN DATA

Continuous power (PRP)	165.0 (kVA)
Continuous power (PRP)	132.0 (kW)
Stand-by power (LTP)	180.0 (kVA)
Stand-by power (LTP)	144.0 (kW)
Voltage • Frequency • Power Factor	415V • 50Hz • 0.8 cosφ
Sound pressure 7 m.	0.0 dBA

DIMENSIONS AND WEIGHT

Width	1100 mm
Length	2390 mm
Height	1790 mm
Weight	1600 kg

ALTERNATOR

Alternator brand	MARELLI
Alternator model	MJB250MA4
P.R.P. Power	165.0 kVA
L.T.P. Power	180.0 kVA
Connection	Series star
Phases	3PH+N
Winding	12 terminals 50-60Hz Winding M0
Terminal Number	12 nr.
IP Protection	23
Electronic regulator	M16FA655A
Precision	0.5 ± %

BASEFRAME

Model	T2
Standard tank	520 l
Optional tank	0 l
Oversized tank*	0 l

CANOPY & SILENCER

Canopy model	SENZA COFANO
Silencer model	MS 15
Silencer outlet diameter	70.0 mm

Standard reference conditions temperature 25°C, altitude 100m asl, relative humidity 30%, atmospheric pressure 100 kPa (1 bar), power factor 0.8 lag, balanced load - non distortional. Fuel consumption is nominal and refers to specific weight 0,850kg/l. Sound power values refer to free field conditions: the installation site may influence the values. Dimensions, weights and other specifications contained in the technical data sheet and related attachments are nominal, subject to tolerances and refer to the model with standard equipment; any optional and additional equipment/accessories can modify weight, dimensions, performance.

P.R.P. Prime Power-Continuous power at variable load: The power that a genset can supply in continuous service at a variable load for an unlimited number of hours per year while respecting the maintenance intervals established in the environmental conditions stated by the Manufacturer. according to ISO8528-1. The average power supplied over time and any applicable overload must be less than the percentages stated by the Manufacturer.

L.T.P. Limited-time running power-Limited power: The maximum power that a genset can supply for a limited time respecting the maintenance intervals established in the environmental conditions stated by the Manufacturer according to ISO 8528-1. The number of hours per year is stated by the Manufacturer. Overload is not permitted.

The data contained in this document is nominal and refers to the standard equipped model and is not binding. Visa S.p.A. reserves the right to revise the information without notice per our policy of continuous product development and improvement.

