

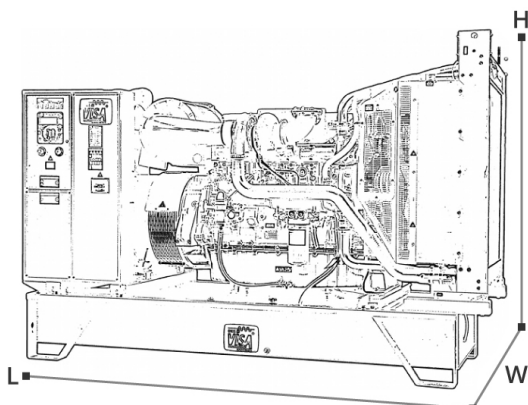

POWERFULL "B"



For illustrative purposes only

ENGINE

Engine brand	VOLVO-PENTA
Engine model	TAD1342GE
Cylinders	6
Speed	1500 r.p.m.
Cubic capacity	12.78 l
Air intake	Turbocharged
Standard voltage	24 Vdc
Optional voltage	Vdc
Sae	1-14
BMEP	2000 kPa
Cooling	Water
Flywheel P.R.P. Power	303.0 kW
Flywheel Stand-by Power	333.0 kW
Fuel Cons. at 100% (L.T.P.)	75.7 l/h
Fuel Cons. at 100% (P.R.P.)	68.9 l/h
Fuel Cons. at 75% (P.R.P.)	52.2 l/h
Fuel Cons. at 50% (P.R.P.)	36.3 l/h
Fuel Cons. at 25% (P.R.P.)	20.2 l/h
Electronic regulator	Standard
Precision class	G3
Oil quantity	36.0 l
Engine Antifreeze capacity	0.0 l
Radiator type	Tropical
Heat from radiator	134.0 kW
Heat from exhaust	195.0 kW
Heat from radiation	0.0 kW
Exhaust temperature	395 °C
Cooling air flow	0.00 m ³ /min
Combustion air flow	24.60 m ³ /min
Exhaust gas flow	0.00 m ³ /min
TA Luft	Not available
TA Luft/2	Not available
EPA	Not available
Stage	Stage 2

MAIN DATA

Continuous power (PRP)	350.0 (kVA)
Continuous power (PRP)	280.0 (kW)
Stand-by power (LTP)	387.0 (kVA)
Stand-by power (LTP)	309.6 (kW)
Voltage • Frequency • Power Factor	400V • 50Hz • 0.8 cosφ
Sound pressure 7 m.	0.0 dBA

DIMENSIONS AND WEIGHT

Width	1300 mm
Length	3000 mm
Height	2030 mm
Weight	3170 kg

ALTERNATOR

Alternator brand	STAMFORD
Alternator model	HCI4E
P.R.P. Power	350.0 kVA
L.T.P. Power	400.0 kVA
Connection	Series star
Phases	3PH+N
Winding	12 terminals Winding 311
Terminal Number	12 nr.
IP Protection	23
Electronic regulator	AS440
Precision	1.0 ± %

BASEFRAME

Model	T3
Standard tank	900 l
Optional tank	0 l
Oversized tank*	0 l

CANOPY & SILENCER

Canopy model	SENZA COFANO
Silencer model	MS 30
Silencer outlet diameter	140.0 mm

Standard reference conditions temperature 25°C, altitude 100m asl, relative humidity 30%, atmospheric pressure 100 kPa (1 bar), power factor 0.8 lag, balanced load - non distortional. Fuel consumption is nominal and refers to specific weight 0,850kg/l. Sound power values refer to free field conditions: the installation site may influence the values. Dimensions, weights and other specifications contained in the technical data sheet and related attachments are nominal, subject to tolerances and refer to the model with standard equipment; any optional and additional equipment/accessories can modify weight, dimensions, performance.

P.R.P. Prime Power-Continuous power at variable load: The power that a genset can supply in continuous service at a variable load for an unlimited number of hours per year while respecting the maintenance intervals established in the environmental conditions stated by the Manufacturer. according to ISO8528-1. The average power supplied over time and any applicable overload must be less than the percentages stated by the Manufacturer.

L.T.P. Limited-time running power-Limited power: The maximum power that a genset can supply for a limited time respecting the maintenance intervals established in the environmental conditions stated by the Manufacturer according to ISO 8528-1. The number of hours per year is stated by the Manufacturer. Overload is not permitted.

